

FEATURES

- Low Supply Current **300 μ A**
- 0.2 μ A Supply Current in SHUTDOWN **\pm 10kV**
- ESD Protection **0.1 μ F**
- Operates From a Single 3.3V Supply
- Uses Small Capacitors
- Operates To 120k Baud
- Three-State Outputs are High Impedance When Off
- Output Overvoltage Does Not Force Current Back Into Supplies
- EIA/TIA-562 I/O Lines Can Be Forced to \pm 25V Without Damage
- Flowthrough Architecture

APPLICATIONS

- Notebook Computers
- Palmtop Computers

DESCRIPTION

The LTC1327 is an advanced low power, three-driver/five-receiver EIA/TIA-562 transceiver. In the no load condition, the supply current is only **300 μ A**. The charge pump only requires four 0.1 μ F capacitors.

In SHUTDOWN mode, the supply current is further reduced to 0.2 μ A. All EIA/TIA-562 outputs assume a high impedance state in SHUTDOWN and with the power off.

The LTC1327 is fully compliant with all data rate and overvoltage EIA/TIA-562 specifications. The transceiver can operate up to 120k Baud with a 1000pF/3k Ω load. Both driver outputs and receiver inputs can be forced to \pm 25V without damage, and can survive multiple \pm 10kV ESD strikes.

TYPICAL APPLICATION

3-Drivers/5-Receivers with SHUTDOWN

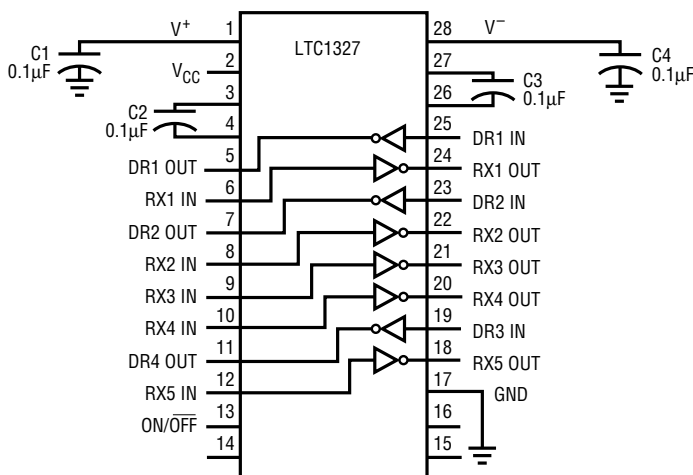

1327 TA01

Supply Current vs Temperature

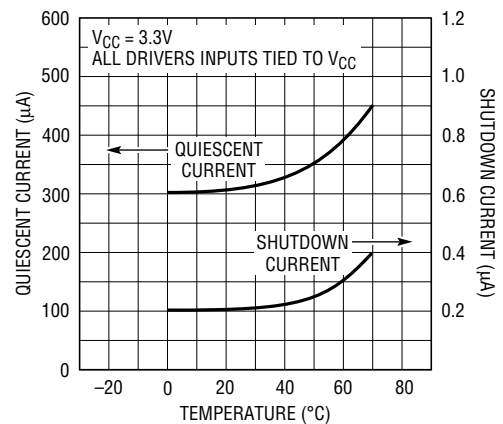

LTC1327 • TA02

ABSOLUTE MAXIMUM RATINGS

Supply Voltage (V_{CC})	5V
Input Voltage	
Driver	-0.3V to ($V_{CC} + 0.3V$)
Receiver	-25V to 25V
On/Off Pin	-0.3V to ($V_{CC} + 0.3V$)
Output Voltage	
Driver	-25V to 25V
Receiver	-0.3V to ($V_{CC} + 0.3V$)
Short-Circuit Duration	
V^+	30 sec
V^-	30 sec
Driver Output	Indefinite
Receiver Output	Indefinite
Operating Temperature Range	
Commercial LTC1327C	0°C to 70°C
Storage Temperature Range	-65°C to 150°C
Lead Temperature (Soldering, 10 sec).....	300°C

PACKAGE/ORDER INFORMATION

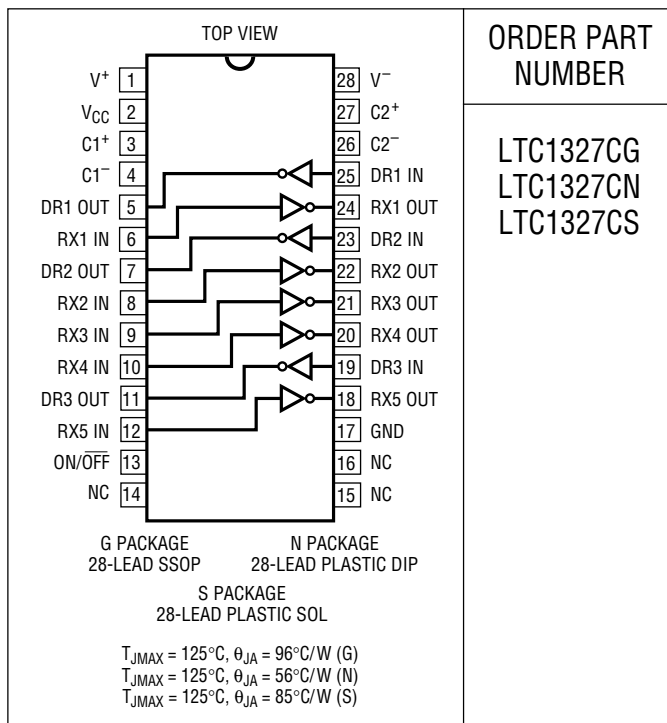

ORDER PART NUMBER

LTC1327CG
LTC1327CN
LTC1327CS

Consult factory for Industrial and Military grade parts.

DC ELECTRICAL CHARACTERISTICS $V_{CC} = 3.3V$, $C1$ to $C4 = 0.1\mu F$, unless otherwise noted.

PARAMETER	CONDITIONS	MIN	TYP	MAX	UNITS
Any Driver					
Output Voltage Swing	Positive Negative (3k to GND)	● ●	3.7 -3.7	4.5 -4.5	V V
Logic Input Voltage Level	Input Low Level ($V_{OUT} = \text{High}$) Input High Level ($V_{OUT} = \text{Low}$)	● ●	2	1.4 1.4	0.8 V
Logic Input Current	$V_{IN} = 3.3$ $V_{IN} = 0$	● ●		5 -5	μA μA
Output Short-Circuit Current	$V_{OUT} = 0V$			± 7	mA
Output Leakage Current	SHUTDOWN (Note 3), $V_{OUT} = \pm 20V$			± 10 ± 500	μA
Any Receiver					
Input Voltage Thresholds	Input Low Threshold Input High Threshold	● ●	0.8	1.3 1.7	2.4 V
Hysteresis		●	0.1	0.4	1 V
Input Resistance	$V_{IN} = \pm 10V$		3	5	7 k Ω
Output Voltage	Output Low, $I_{OUT} = -1.6mA$ ($V_{CC} = 3.3V$) Output High, $I_{OUT} = 160\mu A$ ($V_{CC} = 3.3V$)	● ●	3	0.2 3.2	0.4 V
Output Short-Circuit Current	Sinking Current, $V_{OUT} = V_{CC}$		-2	-10	mA
Output Leakage Current	SHUTDOWN (Note 3), $0 \leq V_{OUT} \leq V_{CC}$	●		1	10 μA

DC ELECTRICAL CHARACTERISTICS $V_{CC} = 3.3V$, $C1$ to $C4 = 0.1\mu F$, unless otherwise noted.

PARAMETER	CONDITIONS	MIN	TYP	MAX	UNITS
Power Supply Generator					
V^+ Output Voltage	$I_{OUT} = 0mA$		5.7		V
	$I_{OUT} = 5mA$		5.5		V
V^- Output Voltage	$I_{OUT} = 0mA$		-5.3		V
	$I_{OUT} = -5mA$		-5.0		V
Supply Rise Time	SHUTDOWN to Turn-On		0.2		ms
Power Supply					
V_{CC} Supply Current	No Load (Note 2)	●	0.3	0.5	mA
Supply Leakage Current (V_{CC})	SHUTDOWN (Note 3)	●	0.2	10	μA
On/Off Threshold Low		●	1.4	0.8	V
On/Off Threshold High		●	2	1.4	V

AC CHARACTERISTICS

Slew Rate	$R_L = 3k, C_L = 51pF$		3	6	30	$V/\mu s$
	$R_L = 3k, C_L = 1000pF$			5		$V/\mu s$
Driver Propagation Delay (TTL to EIA/TIA-562)	t_{HLD}	●		2	3.5	μs
	t_{LHD}	●		2	3.5	μs
Receiver Propagation Delay (EIA/TIA-562 to TTL)	t_{HLR}	●		0.3	0.8	μs
	t_{LHR}	●		0.2	0.8	μs

The ● denotes specifications which apply over the operating temperature ($0^\circ C \leq T_A \leq 70^\circ C$).

Note 1: Absolute Maximum Ratings are those values beyond which the life of the device may be impaired.

Note 2: Supply current is measured with driver and receiver output unloaded and driver inputs tied high.

Note 3: Supply current measurement in SHUTDOWN mode is performed with $V_{ON/OFF} = 0V$.

TYPICAL PERFORMANCE CHARACTERISTICS

Driver Output Voltage vs Temperature

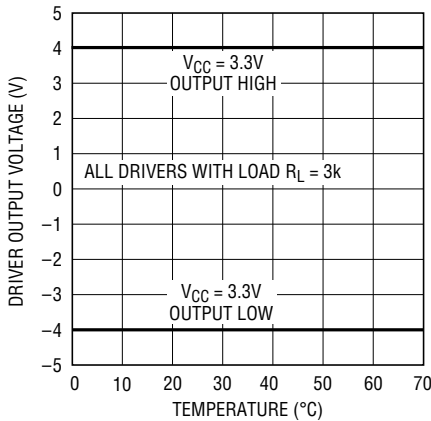

1327 G01

Receiver Input Thresholds vs Temperature

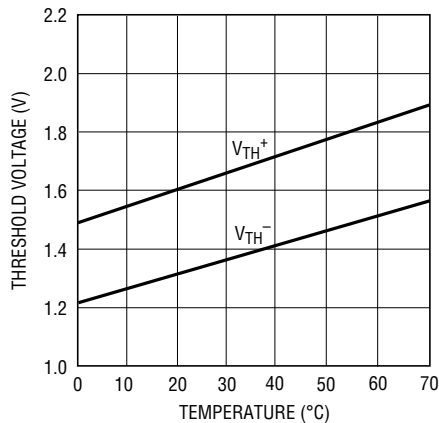

1327 G02

Supply Current vs Data Rate

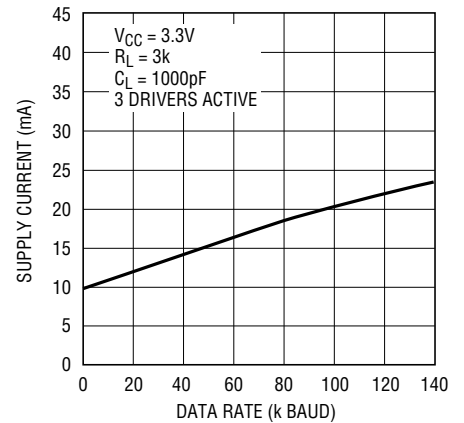

1327 G03

TYPICAL PERFORMANCE CHARACTERISTICS

V_{CC} Supply Current vs Data Rate

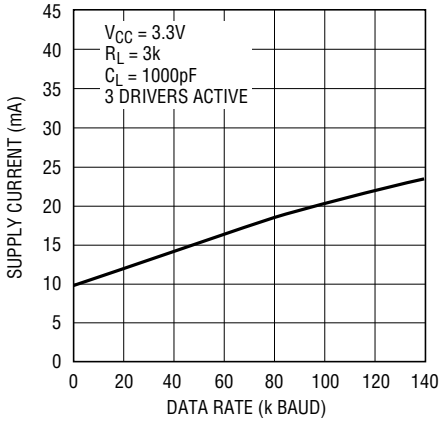

1327 G03

Driver Leakage in SHUTDOWN vs Temperature

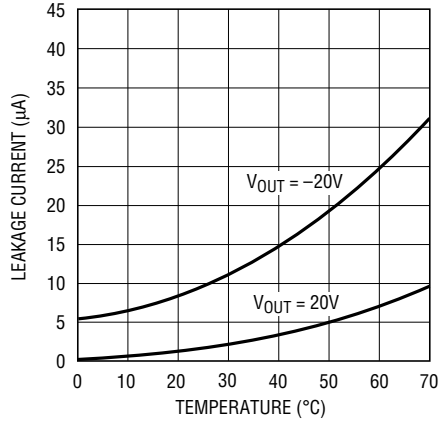

1327 G05

Driver Short-Circuit Current vs Supply Voltage

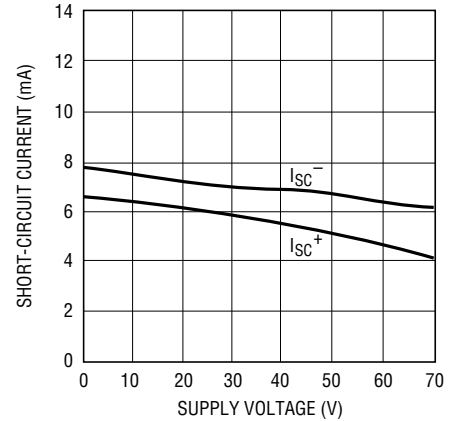

1327 G06

Receiver Short-Circuit Current vs Temperature

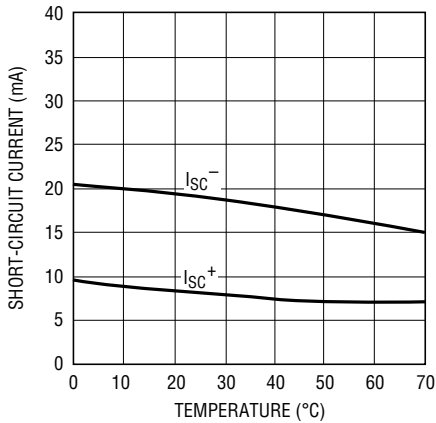

1327 G07

Driver Output Waveform

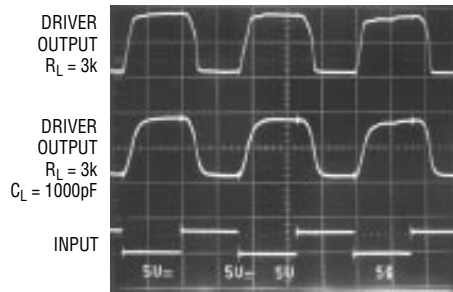

1327 G08

Receiver Output Waveform

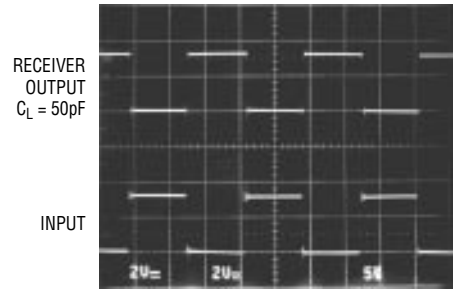

1327 G09

PIN FUNCTIONS

V_{CC}: 3.3V Input Supply Pin. Supply current 0.2µA in the SHUTDOWN mode. This pin should be decoupled with a 0.1µF ceramic capacitor.

GND: Ground Pin.

ON/OFF: TTL/CMOS Compatible Shutdown Pin. A logic low puts the device in SHUTDOWN mode which reduces the supply current to 0.2µA and places all drivers and receivers in high impedance state. This pin cannot float.

V⁺: Positive Supply Output (EIA/TIA-562 Drivers). $V^+ \cong 2V_{CC} - 1V$. This pin requires an external capacitor

$C = 0.1\mu F$ for charge storage. The capacitor may be tied to ground or 3.3V. With multiple devices, the V⁺ and V⁻ pins may be paralleled into common capacitors. For large numbers of devices, increasing the size of the shared common storage capacitors is recommended to reduce ripple.

V⁻: Negative Supply Output (EIA/TIA-562 Drivers). $V^- \cong -(2V_{CC} - 1.3)$. This pin requires an external capacitor $C = 0.1\mu F$ for a charge storage.

PIN FUNCTIONS

C1⁺, C1⁻, C2⁺, C2⁻: Commutating Capacitor Inputs. These pins require two external capacitors $C = 0.1\mu\text{F}$. One from C1⁺ to C1⁻, and another from C2⁺ to C2⁻. To maintain charge pump efficiency, the capacitor's effective series resistance should be less than 20Ω .

DR IN: EIA/TIA-562 Driver Input Pins. Inputs are TTL/CMOS compatible. Inputs should not be allowed to float. Tie unused inputs to V_{CC} .

DR OUT: Driver Outputs at EIA/TIA-562 Voltage Levels. Outputs are in a high impedance state when in SHUT-

DOWN mode or $V_{CC} = 0\text{V}$. The driver outputs are protected against ESD to $\pm 10\text{kV}$ for human body model discharges.

RX IN: Receiver Inputs. These pins can be forced to $\pm 25\text{V}$ without damage. The receiver inputs are protected against ESD to $\pm 10\text{kV}$ for human body model discharges. Each receiver provides 0.4V of hysteresis for noise immunity.

RX OUT: Receiver Outputs With TTL/CMOS Voltage Levels. Outputs are in a high impedance state when in SHUT-DOWN mode to allow data line sharing.

TEST CIRCUITS

ESD Test Circuit

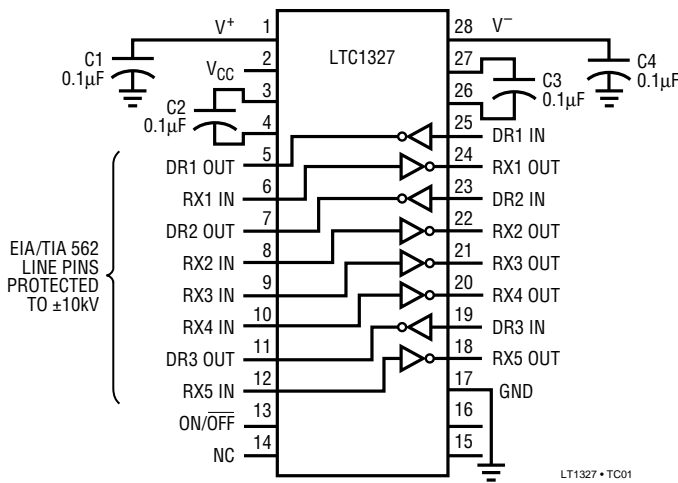

Driver Timing Test Load

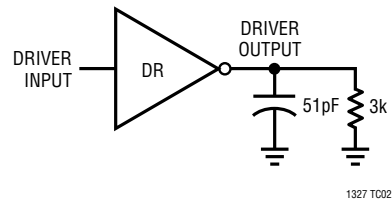

Receiver Timing Test Load

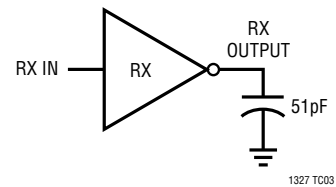

SWITCHING TIME WAVEFORMS

Driver Propagation Delay Timing

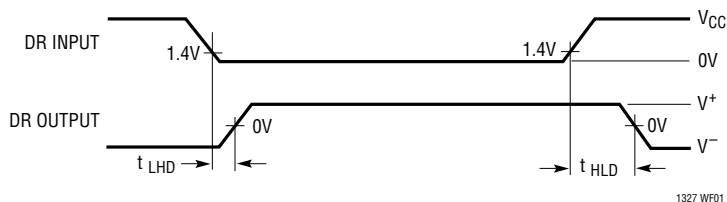

Receiver Propagation Delay Timing

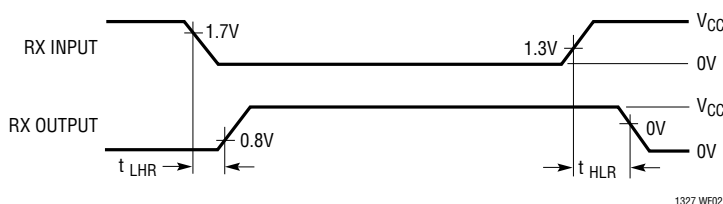

APPLICATIONS INFORMATION

The LTC1327 is compatible with RS232 parts. This table shows some devices and the receiver input thresholds.

MANUFACTURER	PART NUMBER	COMPATIBLE	INPUT LOW THRESHOLD (V _{IL})			INPUT HIGH THRESHOLD (V _{IH})		
			MIN	TYP	MAX	MIN	TYP	MAX
Linear Technology	LT1080	√	0.8	1.3	–	–	1.7	2.4
	LT1137A	√	0.8	1.3	–	–	1.7	2.4
	LT1330	√	0.8	1.3	–	–	1.7	2.4
	LT1281	√	0.8	1.3	–	–	1.7	2.4
	All Others	√						
Texas Instruments	SN75189	√	0.65	1	1.25	0.9	1.3	1.6
	SN75189A	√	0.65	1	1.25	1.55	1.9	2.25
	MAX232	√	0.8	1.2	–	–	1.7	2.4
	SN75C185	√	0.65	1	1.25	1.6	2.1	2.55
Maxim	MAX232A	√	0.8	1.3	–	–	1.8	2.4
	MAX241	√	0.6	1.2	–	–	1.5	2.4
Sipex	SP232	√	0.8	1.2	–	–	1.7	2.4
	SP301	√	0.75	–	1.35	1.75	2.5	
Motorola	MC1489	√	0.75	–	1.25	1	–	1.5
	MC1489A	√	0.75	0.8	1.25	1.75	1.95	2.25
National	DS1489	√	0.75	1	1.25	1	1.25	1.5
	DS14C89A	√	0.5	–	1.9	1.3	–	2.7

PACKAGE DESCRIPTION Dimensions in inches (millimeters) unless otherwise noted.

**G Package
28-Lead SSOP**

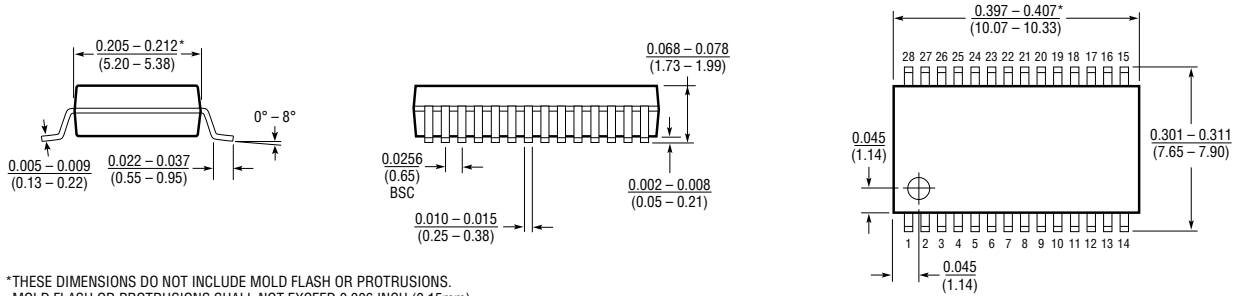

*THESE DIMENSIONS DO NOT INCLUDE MOLD FLASH OR PROTRUSIONS.
MOLD FLASH OR PROTRUSIONS SHALL NOT EXCEED 0.006 INCH (0.15mm).

**N Package
28-Lead Plastic DIP**

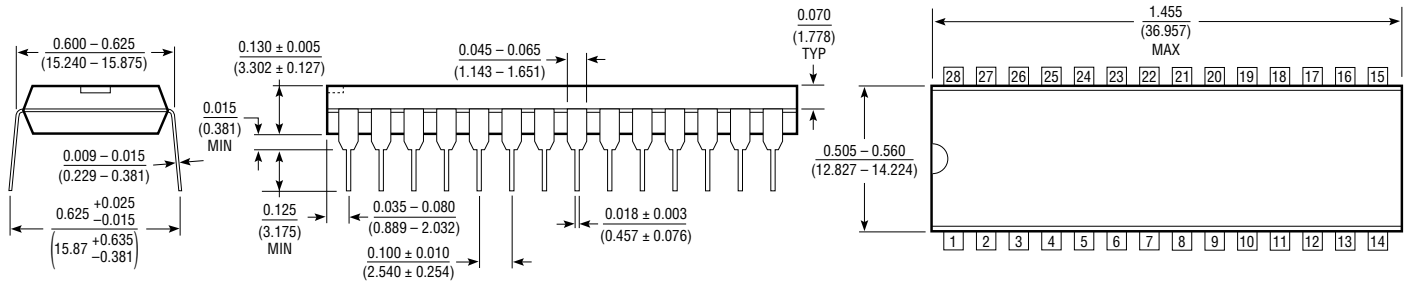

**S Package
28-Lead Plastic SOL**

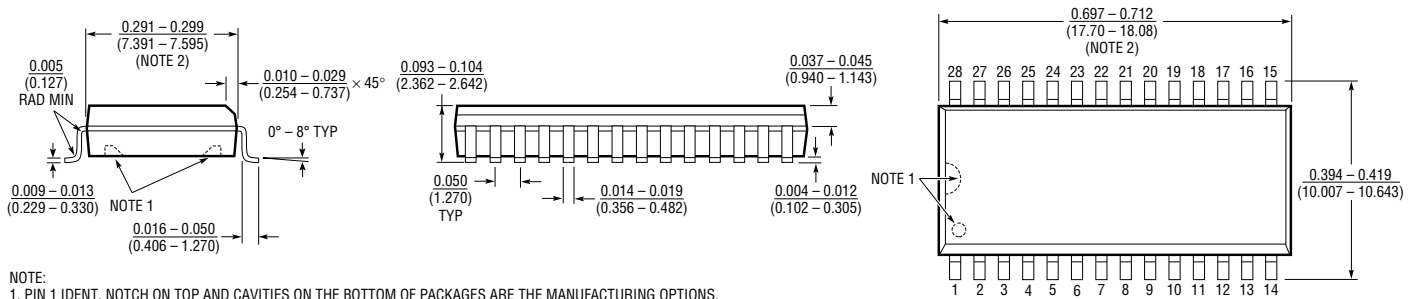

NOTE:
1. PIN 1 IDENT, NOTCH ON TOP AND CAVITIES ON THE BOTTOM OF PACKAGES ARE THE MANUFACTURING OPTIONS.
THE PART MAY BE SUPPLIED WITH OR WITHOUT ANY OF THE OPTIONS.
2. THESE DIMENSIONS DO NOT INCLUDE MOLD FLASH OR PROTRUSIONS.
MOLD FLASH OR PROTRUSIONS SHALL NOT EXCEED 0.006 INCH (0.15mm).

U.S. Area Sales Offices

NORTHEAST REGION

Linear Technology Corporation
One Oxford Valley
2300 E. Lincoln Hwy., Suite 306
Langhorne, PA 19047
Phone: (215) 757-8578
FAX: (215) 757-5631

Linear Technology Corporation

266 Lowell St., Suite B-8
Wilmington, MA 01887
Phone: (508) 658-3881
FAX: (508) 658-2701

SOUTHEAST REGION

Linear Technology Corporation
17060 Dallas Parkway
Suite 208
Dallas, TX 75248
Phone: (214) 733-3071
FAX: (214) 380-5138

CENTRAL REGION

Linear Technology Corporation
Chesapeake Square
229 Mitchell Court, Suite A-25
Addison, IL 60101
Phone: (708) 620-6910
FAX: (708) 620-6977

SOUTHWEST REGION

Linear Technology Corporation
22141 Ventura Blvd.
Suite 206
Woodland Hills, CA 91364
Phone: (818) 703-0835
FAX: (818) 703-0517

NORTHWEST REGION

Linear Technology Corporation
782 Sycamore Dr.
Milpitas, CA 95035
Phone: (408) 428-2050
FAX: (408) 432-6331

International Sales Offices

FRANCE

Linear Technology S.A.R.L.
Immeuble "Le Quartz"
58 Chemin de la Justice
92290 Chatenay Malabry
France
Phone: 33-1-41079555
FAX: 33-1-46314613

GERMANY

Linear Technolgy GMBH
Untere Hauptstr. 9
D-85386 Eching
Germany
Phone: 49-89-3197410
FAX: 49-89-3194821

JAPAN

Linear Technology KK
5F YZ Bldg.
4-4-12 Iidabashi, Chiyoda-Ku
Tokyo, 102 Japan
Phone: 81-3-3237-7891
FAX: 81-3-3237-8010

KOREA

Linear Technology Korea Branch
Namsong Building, #505
Itaewon-Dong 260-199
Yongsan-Ku, Seoul
Korea
Phone: 82-2-792-1617
FAX: 82-2-792-1619

SINGAPORE

Linear Technology Pte. Ltd.
101 Boon Keng Road
#02-15 Kallang Ind. Estates
Singapore 1233
Phone: 65-293-5322
FAX: 65-292-0398

TAIWAN

Linear Technology Corporation
Rm. 801, No. 46, Sec. 2
Chung Shan N. Rd.
Taipei, Taiwan, R.O.C.
Phone: 886-2-521-7575
FAX: 886-2-562-2285

UNITED KINGDOM

Linear Technology (UK) Ltd.
The Coliseum, Riverside Way
Camberley, Surrey GU15 3YL
United Kingdom
Phone: 44-276-677676
FAX: 44-276-64851

World Headquarters

Linear Technology Corporation
1630 McCarthy Blvd.
Milpitas, CA 95035-7487
Phone: (408) 432-1900
FAX: (408) 434-0507